

Loading Diagram/承载图

Max (170 bar)	12 volt	24 volt
Pump-Motor Unit/马达电流	220A	120A
Magnet (electric safety valve)/ 电磁线圈电流	1.5A	0.75A
Solenoid/接触器电流	1.8A	0.9A
Cable area/电缆配置:		
Control cable/控制线	1.0mm ²	1.0mm ²
Main cable 0-10m/主电缆	25mm ²	25mm ²
Power source/车载电瓶配置:		
Min.capacity/最小容量	140 Ah	120 Ah
Min.voltage/最低电压	9 Volt	18 Volt

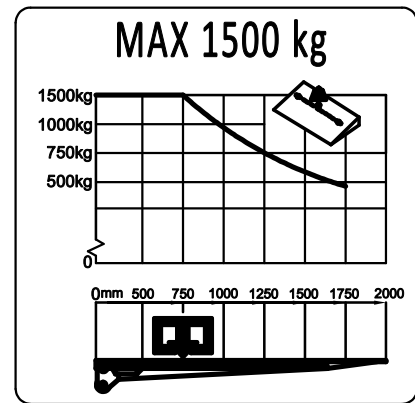

Installation Dimension (mm)

安装尺寸图

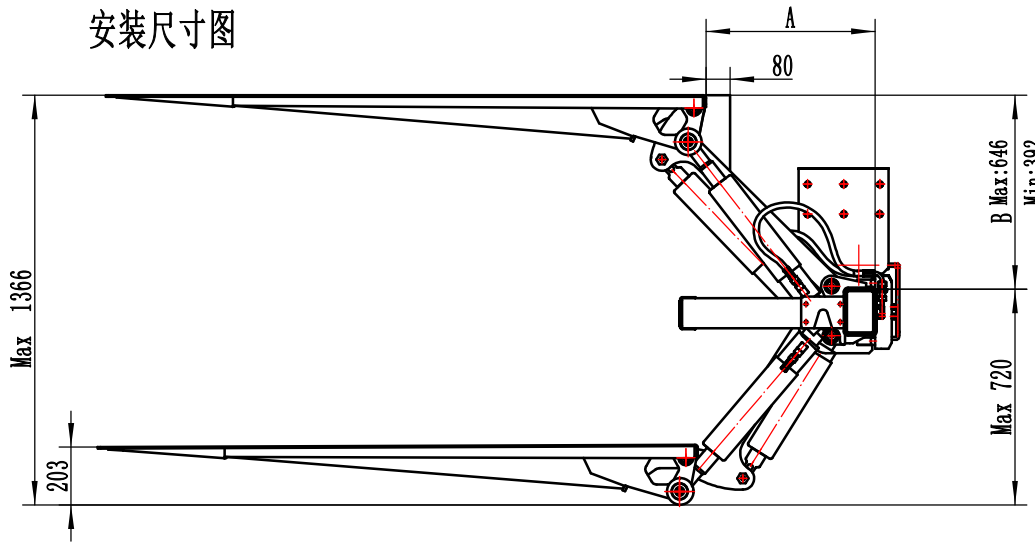

JLC15-130	
A	B
563	646
634	587
691	523
737	458
775	392

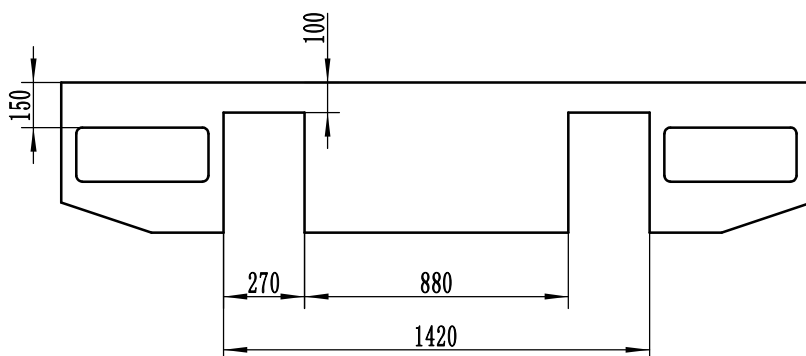
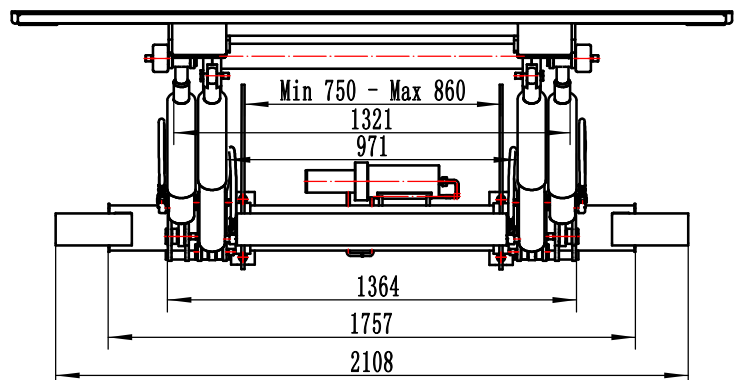
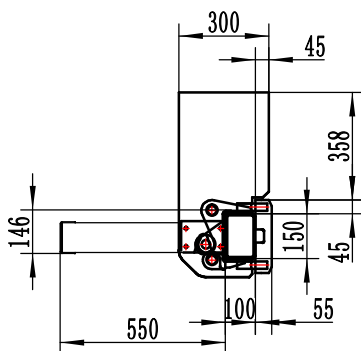

LOADTEC

Tel:0715 8116933

Internet:www.loadteclift.com